

Affordable, luxurious,  
easy fit solid surfaces



minerva®

minerva®  
FITTING PERFECTION



minerva® Silver Haze worksurface

# Solid performance...

minerva® solid worksurfaces are manufactured to a full 25mm thickness with colour throughout.

Welcome to **minerva**®: the home of practical and solid kitchen worksurface material, manufactured using state-of-the-art technology. Delivering a luxurious appearance, cool pleasing touch and robust performance day in, day out. With a 10-year guarantee against manufacturing defects, style is not compromised for quality.

Imperceptible, seamless joints with full design flexibility. Aspirations are a reality. Whether you dream of sweeping curves or contemporary lines, **minerva**® offers the flexibility to meet all your design needs without the cost of specialist installation. Please take a look through our brochure and contemplate some of the possibilities. Your imagination will provide the rest!

## contents...

- 06 Factory machined face & edges
- 08 Faster lead times
- 12 Imperceptible, seamless solid joints
- 14 Pre-fabricated features
- 18 Sink modules
- 20 **minerva**® décor collection
- 22 A new dimension in **minerva**® Calcutta White
- 24 Standard ranges & sizes
- 26 Custom service
- 27 **minerva**® guarantee

# ...total design flexibility

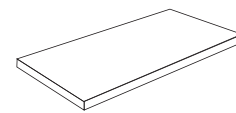

**FACTORY MACHINED FACE & EDGES, ALL FINISHED BY HAND**

All **minerva**® worksurfaces are supplied ready for installation with smooth factory machined face & edges all finished by hand.

No need, therefore, for time consuming and messy preparation work as face & edges are finished and ready for fitting.



**FASTER LEAD TIMES, QUICKER INSTALLATION**

**minerva**® cuts the wait and cost usually associated with choosing solid worksurfaces, saving you time and money.

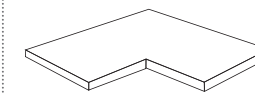

**IMPERCEPTIBLE, SEAMLESS, SOLID JOINTS**

Whether you are using the services of a professional installer or doing the job yourself, **minerva**® is designed to deliver the best possible aesthetic results.

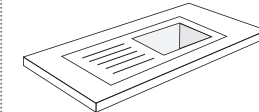

**PRE-FABRICATED FEATURES**

Undermounted bowls teamed with designer drainer grooves, breakfast bars, splashbacks and upstands, these are just some of the added attractions of choosing **minerva**® for your kitchen.

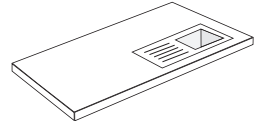

**CUSTOM SERVICE**

Rather than fabricating on-site, bespoke worktops can be manufactured in our factory as per your unique kitchen designs.





minerva® Grey Crystal worksurface

## Factory machined face & edges, all finished by hand



minerva® Calcutta White worksurface



minerva® Desert Rock worksurface



minerva® Ice Crystal worksurface

All **minerva**® worksurfaces are supplied with smooth factory machined face and edges, all finished by hand.

We cut and hand finish the worksurface face and edges for you, so they are delivered ready to fit, saving you valuable installation time and money.

No need to spend time on site making sure the finished face and edges are square and presentable, it's all been done for you.

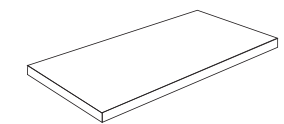

**minerva**®



minerva® Amazonia Brown - infinite design options



minerva® Ice Crystal - stylish upstands are hygienic and easy to clean



minerva® Caramel Crunch - worksurfaces can be easily cut on-site to produce concave and convex curved corners



minerva® Black Granite and Carrara White

## Faster lead times... quicker installation

No specialist equipment, no specialist installation...no time wasted

With **minerva**® there is no waiting for complicated templates to be produced and risk expensive delays. All **minerva**® worksurfaces are factory machined and then finished by hand, delivered ready for installation...it's that quick, it's that simple.



The versatility of **minerva**® allows for any shape of your choice. Both concave and convex curved corners can be easily cut on-site with standard woodworking tools by any experienced kitchen fitter.

**minerva**®



minerva®

minerva®

minerva®

minerva®

minerva®

minerva®

minerva®

minerva®

minerva®

minerva®

minerva®

minerva®

minerva®

minerva®

minerva®

minerva®

minerva®

minerva®

minerva®

minerva®

minerva®

minerva®

minerva®

minerva®

minerva®

**minerva®**



minerva® White worksurface with upstand delivers clean flowing lines



minerva® Carrara White is a veined décor reflecting the natural appeal of stone



minerva® Peak Stone with the cool touch of solid stone



minerva® Sparkling White is reassuringly elegant with just the right amount of sparkle

# Imperceptible, seamless, solid joints

Smooth flowing lines, even across the joint

Every **minerva**® joint is hygienic and seamless to touch. An imperceptible joint can be achieved with most décors. Our veined décors are completely unique, therefore visual difference between joints is to be expected.

There are no specialist preparation procedures required to achieve beautiful imperceptible, seamless joints

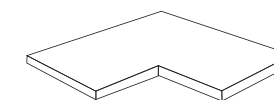

**minerva**®

minerva® Carrara White with pre-fabricated 1.5 bowl acrylic sink



minerva® Nimbus Grey worksurface

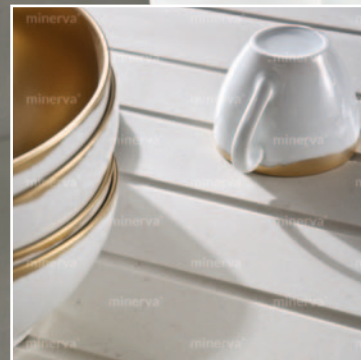

minerva® Fossil - factory machined drainer grooves add depth and dimension

# Pre-fabricated features

With fabrication built-in, **minerva®** saves valuable time when it comes to preparation and installation.

All working faces and edges are factory machined and hand finished, which means there's no time wasted on site. Select an undermounted stainless steel or acrylic sink from the **minerva®** collection. Factory pre-fabricated for easy and quick installation.

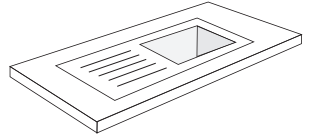

**minerva®** sink modules are made from a solid piece of material, the recessed sections may have a slightly different pattern on some décors due to the spread of the coloured chips.



minerva® Ice Blue worksurface

Due to the production process of **minerva®** Copper Fleck worksurfaces, the particulate can be felt in the finished surface giving it a textured feel. This is quite normal and does not affect the use of the worksurface.



minerva® Copper Fleck

# minerva®





minerva®

minerva®

minerva®

minerva®

Miele minerva®

minerva®

minerva®

minerva®

minerva®

minerva®

minerva®

minerva®

minerva®

minerva®

minerva®

minerva®

minerva®

minerva®

minerva®

minerva®

minerva®

minerva®

minerva®

minerva®

minerva®

minerva®

minerva®

# minerva® ...sink modules, it's your choice

All minerva® sink modules are supplied as either left or right hand bowl which must be specified at the time of order. Images shown are left hand bowl. Both stainless steel and acrylic bowls are suitable for use with waste disposal units. Only stainless steel bowls are suitable for use with instant hot water taps. Whilst minerva® sink modules are made from a solid piece of material, the recessed sections may have a slightly different pattern on some décors due to the spread of the coloured chips. Our acrylic bowls aren't suitable for use with boiling water taps. Allowing boiling water to run freely into acrylic bowls over a period of time may result in superficial crazing of the acrylic surface. When straining boiling water from vegetables etc. we recommend you always run the cold water tap to help prolong the quality of the sink.



## single bowl

minerva® single bowl...650mm deep with recessed drainer area. Pre drilled for tap and pop-up waste. Includes brushed stainless steel bowl, pop-up waste, fitting clips and sealant.

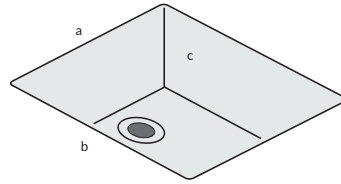

single bowl

- a. 340mm
- b. 400mm
- c. 190mm



## single bowl acrylic

minerva® single bowl acrylic... 650mm deep with recessed drainer area. Pre-drilled for tap. Includes factory fitted single bowl acrylic sink and pop-up waste.

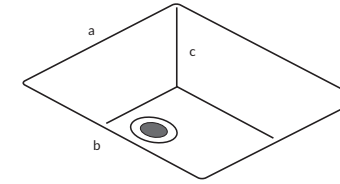

single bowl acrylic

- a. 340mm
- b. 400mm
- c. 190mm



## super large bowl

minerva® super large bowl...650mm deep with recessed drainer area. Pre drilled for tap and pop-up waste. Includes brushed stainless steel bowl, pop-up waste, fitting clips and sealant.

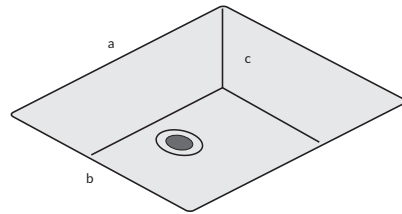

super large bowl

- a. 480mm
- b. 400mm
- c. 200mm



## super large bowl acrylic

minerva® super large bowl...650mm deep with recessed drainer area. Pre drilled for tap and pop-up waste. Includes factory fitted single bowl acrylic sink and pop-up waste.

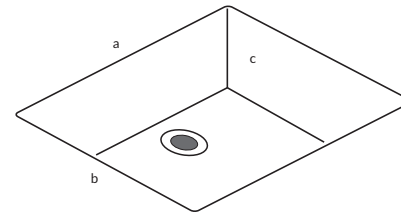

super large bowl acrylic

- a. 480mm
- b. 400mm
- c. 200mm



## 1.5 bowl duo

minerva® 1.5 bowl...650mm deep with recessed drainer area. Pre drilled for tap and pop-up waste. Includes brushed stainless steel main bowl and separate small bowl, basket strainer, pop-up waste, fitting clips and sealant.

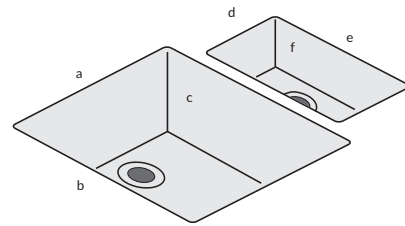

1.5 bowl

- a. 340mm
- b. 400mm
- c. 190mm
- d. 160mm
- e. 300mm
- f. 120mm



## 1.5 bowl duo acrylic

minerva® 1.5 duo bowl acrylic... 650mm deep with recessed drainer area. Pre-drilled for tap. Includes factory fitted 1.5 bowl acrylic sink, basket strainer and pop-up waste.

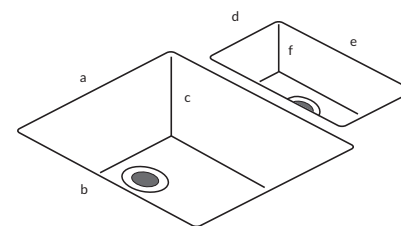

1.5 bowl duo acrylic

- a. 340mm
- b. 400mm
- c. 190mm
- d. 160mm
- e. 300mm
- f. 120mm



## 1.5 designer bowl

minerva® 1.5 designer bowl...650mm deep with recessed drainer area. Pre-drilled for tap. Includes combined 1.5 bowl brushed stainless steel sink, basket strainers, fitting clips and sealant.

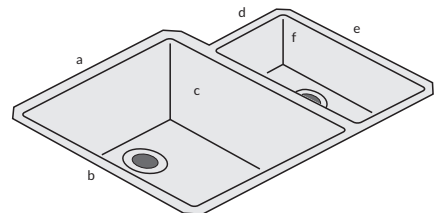

1.5 designer bowl

- a. 340mm
- b. 400mm
- c. 190mm
- d. 160mm
- e. 300mm
- f. 120mm







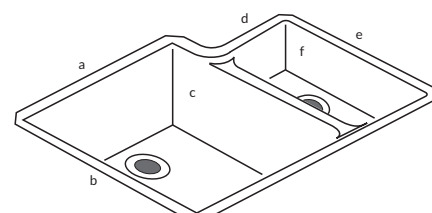

## 1.5 designer bowl acrylic

minerva® 1.5 designer bowl acrylic...650mm deep with recessed drainer area. Pre-drilled for tap. Includes factory fitted combined 1.5 bowl acrylic sink and basket strainers.



1.5 designer bowl acrylic

- a. 340mm
- b. 400mm
- c. 190mm
- d. 160mm
- e. 300mm
- f. 120mm

**KEY:**  
 This sink is suitable for use with a boiling water tap  
 Do not install a boiling water tap with this sink  
 Will fit into 500mm base cabinet  
 Will fit into 600mm base cabinet  
 Will fit into base cabinet openings over 650mm  
 All bowls are SS304 (18/10) grade stainless steel

# minerva® décor collection

\*Each of these worksurfaces are unique, reflecting the natural appeal of marble and stone.

Whilst minerva® sink modules are made from a solid piece of material, the recessed sections may have a slightly different pattern on some decors due to the spread of the coloured chips. Due to the nature of the particulate used in producing minerva® Copper Fleck solid worksurfaces, it is possible that some slight unevenness may be felt in the finished surface. This added texture is quite normal and does not affect the use of the worktop.



NEW

minerva® Calcutta White\* (CT)  
Price Group 4

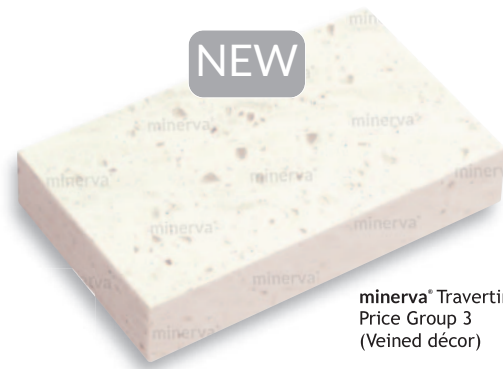

NEW

minerva® Travertine Haze\* (TH)  
Price Group 3  
(Veined décor)



NEW

minerva® Silver Haze\* (SH)  
Price Group 3  
(Veined décor)



NEW

minerva® Concrete Haze\* (CH)  
Price Group 3  
(Veined décor)



minerva® Ice Crystal (IC)  
Price Group 2



minerva® White (WH)  
Price Group 1



minerva® Caramel Crunch (CC)  
Price Group 2



minerva® Fossil (FO)  
Price Group 2



minerva® Sparkling White (SW)  
Price Group 3



minerva® Grey Crystal (GC)  
Price Group 2



minerva® Desert Rock\* (DR)  
Price Group 3  
(Veined décor)



minerva® Amazonia Brown (AB)  
Price Group 2

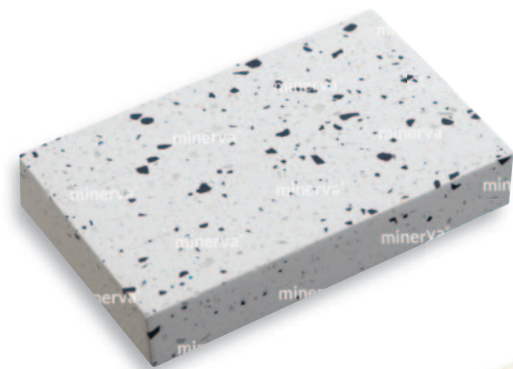

minerva® Ice Blue (IB)  
Price Group 2



minerva® Carrara White\* (CA)  
Price Group 3  
(Veined décor)

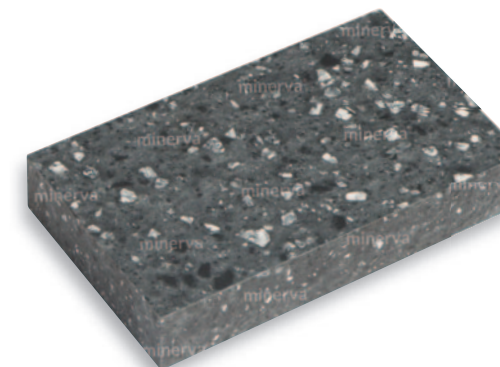

minerva® Nimbus Grey (NG)  
Price Group 2

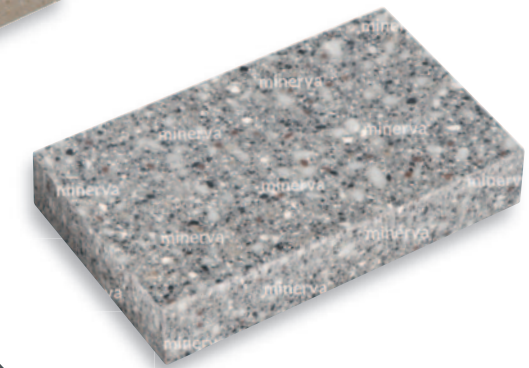

minerva® Peak Stone (PS)  
Price Group 2



minerva® Copper Fleck (CF)  
Price Group 3

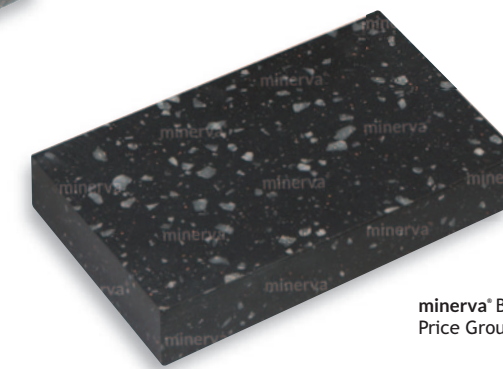

minerva® Black Granite (BG)  
Price Group 2

Price Group 1 (WH) White

Price Group 2 (IC) Ice Crystal, (FO) Fossil, (AB) Amazonia Brown, (IB) Ice Blue, (PS) Peak Stone, (NG) Nimbus Grey, (BG) Black Granite, (GC) Grey Crystal, (CC) Caramel Crunch,

Price Group 3 (CA) Carrara White\*, (CF) Copper Fleck, (DR) Desert Rock\*, (SW) Sparkling White, (SH) Silver Haze\*, (CH) Concrete Haze\*, (TH) Travertine Haze\*

Price Group 4 (CT) Calcutta White\*

minerva® Calcutta White



NEW



minerva® Calcutta White - pre-fabricated recessed drainer grooves



minerva® Calcutta White - seamless joints

# A new dimension in minerva®

With a new island and breakfast bar, unique to minerva® Calcutta White

• Island  
3050 x 1240 x 25mm\*

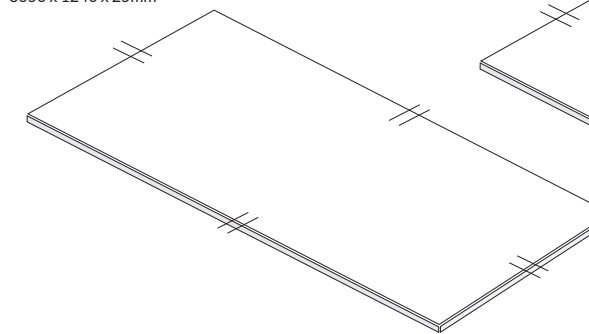

• Breakfast bar  
3050 x 940 x 25mm\*

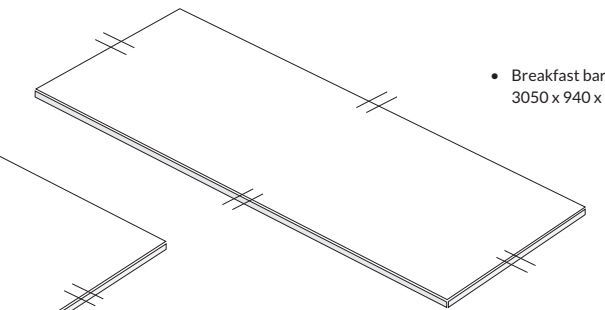

|| Factory finished edge

\* sizes unique to minerva® Calcutta White



minerva® Calcutta White - shown with a 1.5 designer bowl

Due to the unique production method used to make minerva® Calcutta White, we are able to offer larger islands and breakfast bars as a standard item. This allows the full veined effect across your feature island.

# minerva®

# Standard range & sizes

## Worksurfaces

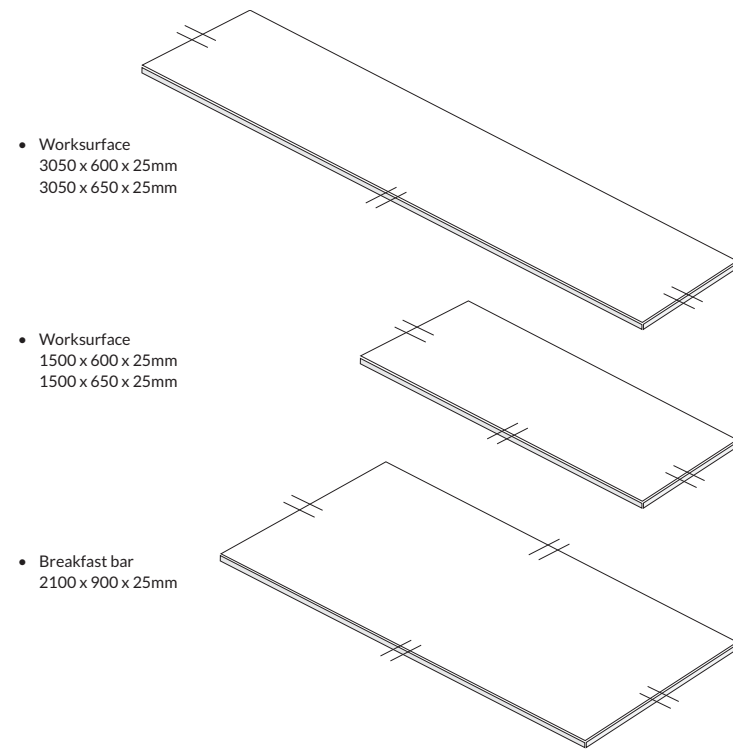

## Splashbacks & Upstands

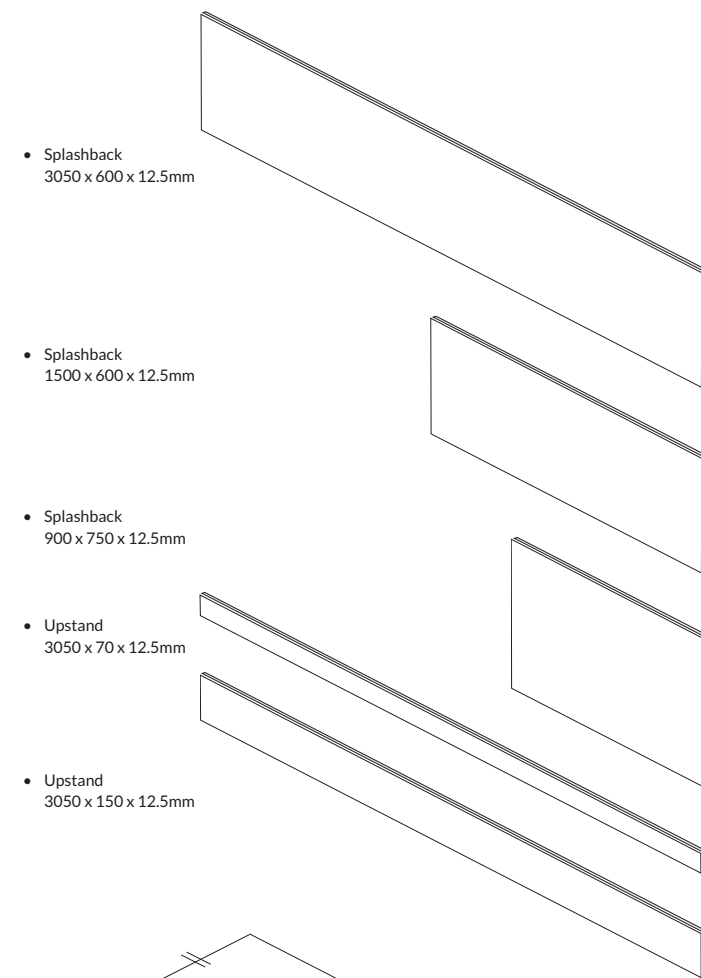

## Sink Modules

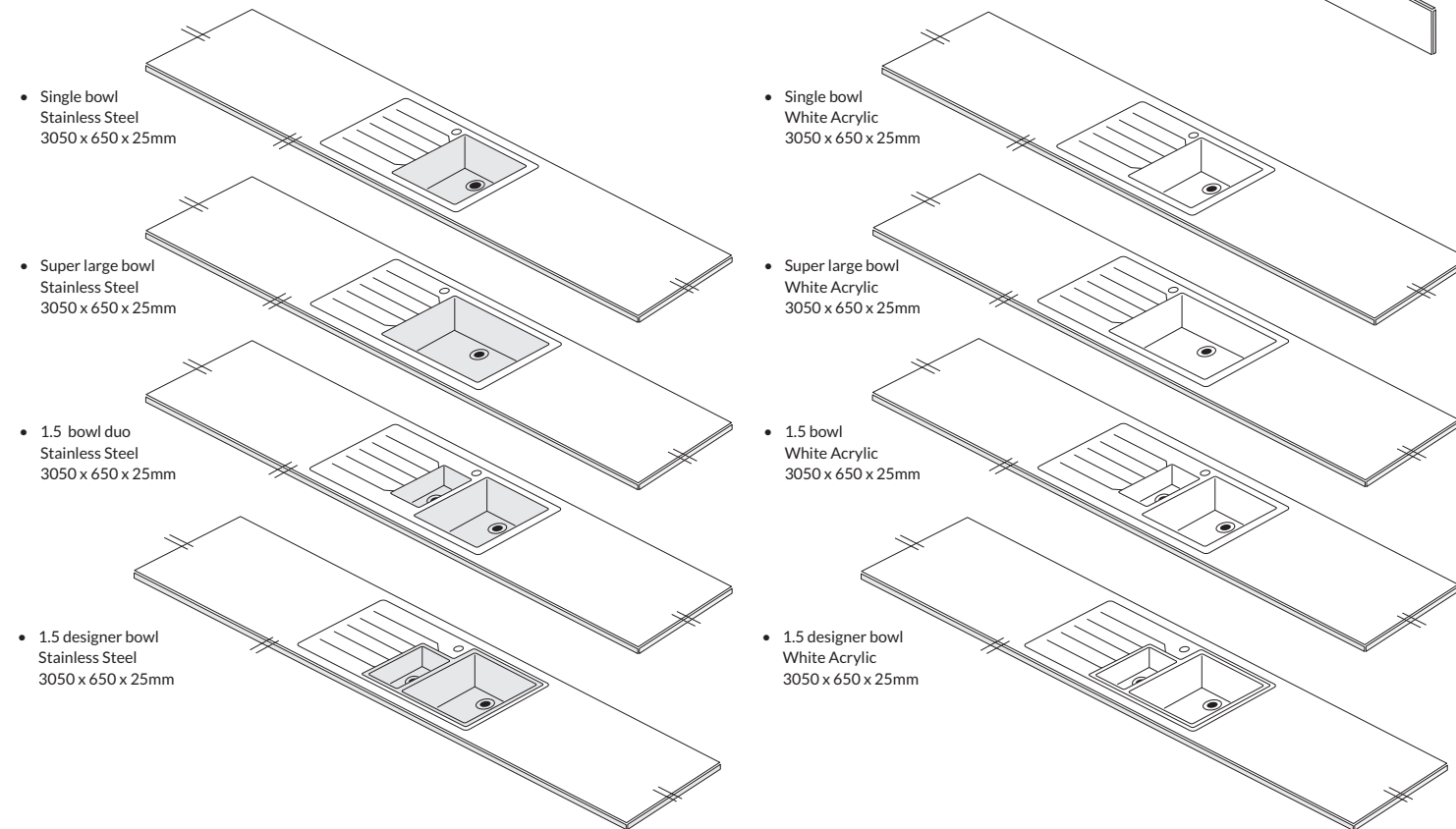

- Stainless steel bowls supplied separately for easy on site fixing
- Acrylic bowls are factory fitted
- All décors are available in these sizes as standard

||| Factory finished edge      — Unfinished edges





**minerva** Amazonia Brown - by joining two pieces of solid surface together in our factory, larger size island worktops can be fabricated. All non-standard worktop configurations come with factory machined face and edges, all finished by hand, ready for installation



**minerva** Sparkling White - hob cut-outs are prepared easily on-site making larger size island worktops ideal for food preparation and meal times



**minerva** Fossil - sink and drainer grooves are located to one side of this bespoke breakfast bar. If you require a non-standard sink module, we will happily reposition the sink plate as per your design requirements



**minerva** Carrara White - edge detail can completely change the appearance of a worktop

# Custom service

Your kitchen should be everything you've dreamed of

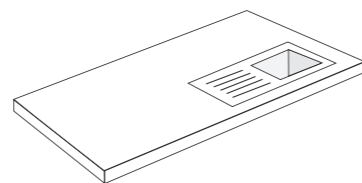

Our Custom Service department specialises in producing the extraordinary.

Rather than fabricating on-site, bespoke worktops can be manufactured in our factory as per your unique kitchen designs... we call it Custom Service.

All of our **minerva** sinks and drainer grooves are located centrally within the sink module. With Custom Service, we can locate your sink and drainer grooves anywhere, often to the far left or far right of the worktop.

Requests for larger island sizes are welcomed, these are achieved by seamlessly joining two pieces of solid surface together.

**minerva** solid surfaces come with our 10 year guarantee\* and are supported by the FIRA Gold Award for product excellence - this is testimony to the fact that we use only the most superior materials and our products are constantly tested to ensure they are manufactured to the highest standards.



**minerva** has been developed for the domestic environment, especially the kitchen. Although no 'special' maintenance is needed, we recommend the following is adhered to, as prevention is always better than cure.



### Routine cleaning

**minerva** does not require any specialist cleaning regimes, most dirt and light residue will easily wipe off with a damp cloth and soapy water. The worksurface should then be rinsed with clean water and wiped dry. Persistent marks can be removed by using a mild abrasive cleaner, but harsh scouring powders should be avoided. If in doubt, consult our care and maintenance guide.

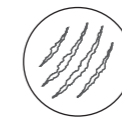

### Minor scratching

Kitchen utensils and crockery (particularly unglazed bases) can sometimes cause scratches that will be more evident on darker colours. The surface can be damaged by scratching or cutting with knives, so the use of a cutting board is essential. Any minor scratches can easily be removed using the grey abrasive pad and other items from the **minerva** care kit. Please refer to the care and maintenance guide.



### Heat

**minerva**'s surface will withstand heat better than many alternative surface materials. However, all hot pots, pans and other heat generating devices should always be placed on a trivet or worktop protector rods to prevent extreme heat having prolonged and direct contact with the surface. Boiling water and cooking splashes do not harm the surface.



### minerva care kit

To help maintain your **minerva** worksurface, a care kit is available from your retailer. This kit contains all you need to make minor repairs to the surface and a special cleaner that helps to maintain, protect and build up lustre, particularly on darker colours.



### Staining

**minerva**, unlike marble and granite, is not porous and will resist most household chemicals including alcohol and cosmetics, however, some chemicals and strong dyes can cause damage and discolouration. If spillage occurs, wipe off immediately and rinse area thoroughly.



### Our commitment to customer service

When you choose **minerva** you do so secure in the knowledge that you are buying a proven, reliable product; a product that is truly at the forefront of modern worksurface technology.

Our Customer Care department is on hand to offer you help, support and advice all year round.

Call: 01773 521 300

\*Guarantee covers manufacturing not installation.



### Standard woodworking tools

**minerva** can easily be cut on site ready for jointing using standard woodworking tools and equipment.

### Accessories

- **minerva** jointing kit (75ml adhesive sachet, sanding discs and grey abrasive pad to finish)
- Individual 75ml adhesive sachet
- Installation, care and maintenance DVD
- Stainless steel finish worktop protector rods (pack of 6)



- **minerva** care kit (countertop cleaner, ergonomic foam sanding pad, microfibre cleaning cloth, 320 grit and 500 grit sanding discs and grey abrasive pad)

### Quality assured

- ✓ Barcol Hardness - EN59
- ✓ Light Fastness - ISO 4892
- ✓ Fungal Resistance - EN ISO 846
- ✓ Food Safety - EN V 1186
- ✓ Bacterial Resistance - EN ISO 846
- ✓ Exposure to Dry Heat - EN 438-2.8

**minerva**®

# minerva®



minerva® Travertine Haze



minerva® Silver Haze



minerva® Concrete Haze



Azalea Close Clover Nook Industrial Park  
Alfreton Derbyshire DE55 4QX

t 01773 521 300 e sales@minervaworksurfaces.co.uk www.minervaworksurfaces.co.uk



minerva® is a registered trademark of Sylmar Technology Limited. Copyright © Sylmar Technology Limited 2019

Disclaimer: Colours are as accurate as the printing process allows. As part of a process of on-going innovation, we reserve the right to change specifications without prior notice.